

# LAYER I

RESOLUTION ID

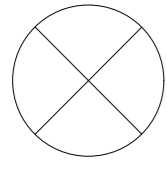

BEAM DIRECTION

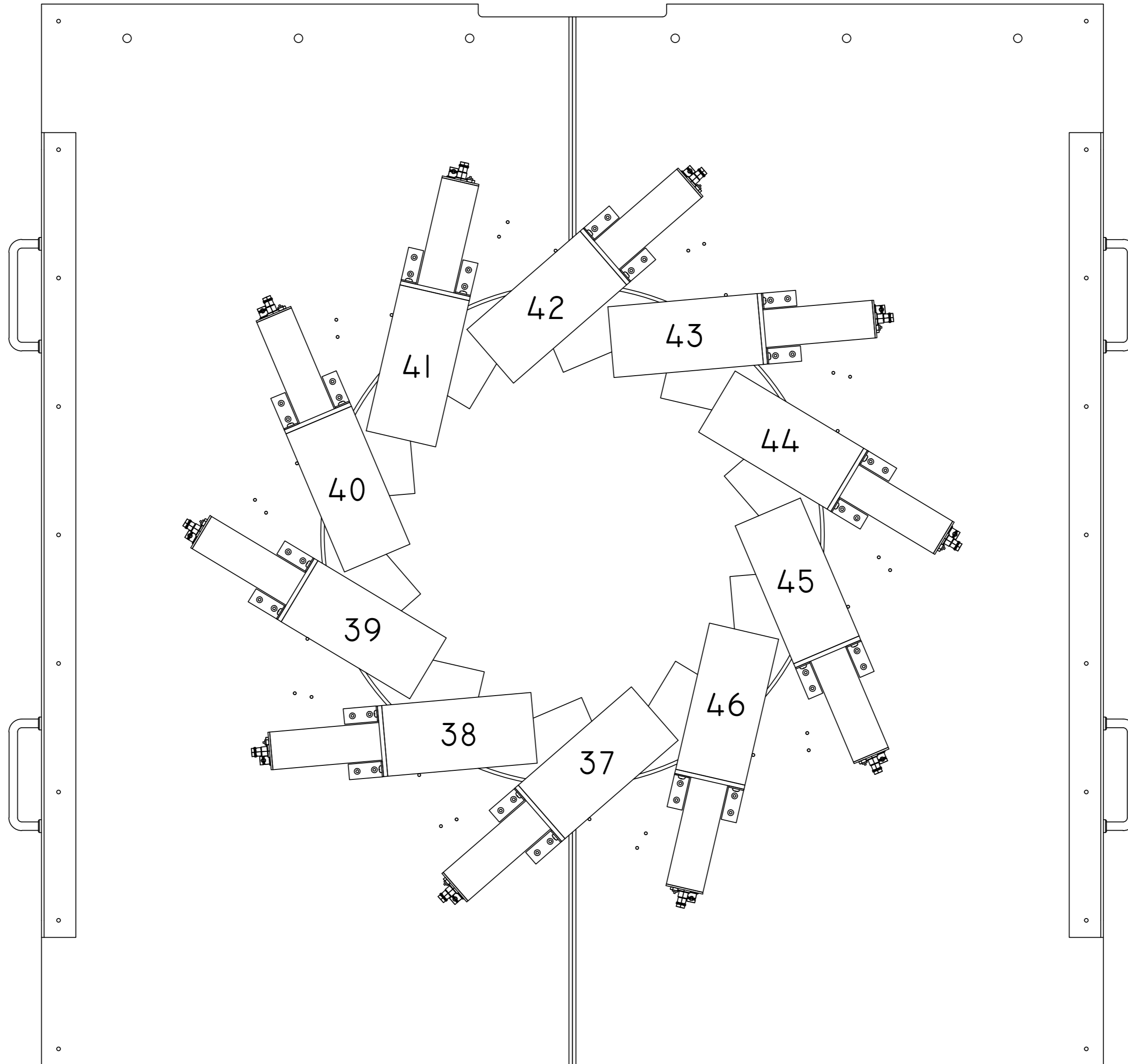

# LAYER 2

RESOLUTION ID

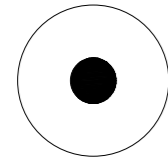

BEAM DIRECTION

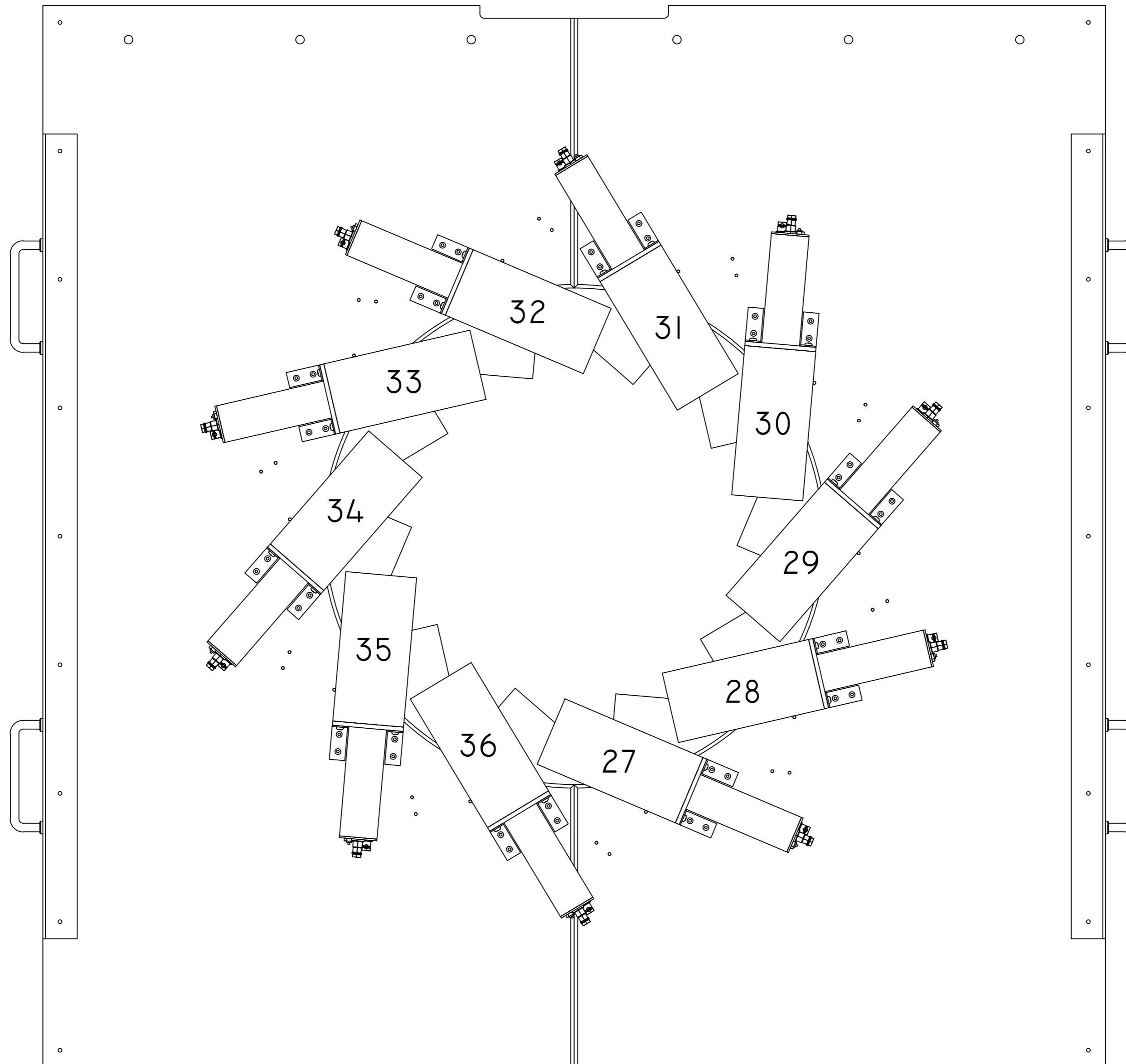

# LAYER 3

RESOLUTION ID

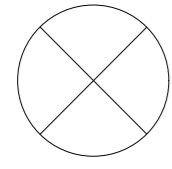

BEAM DIRECTION

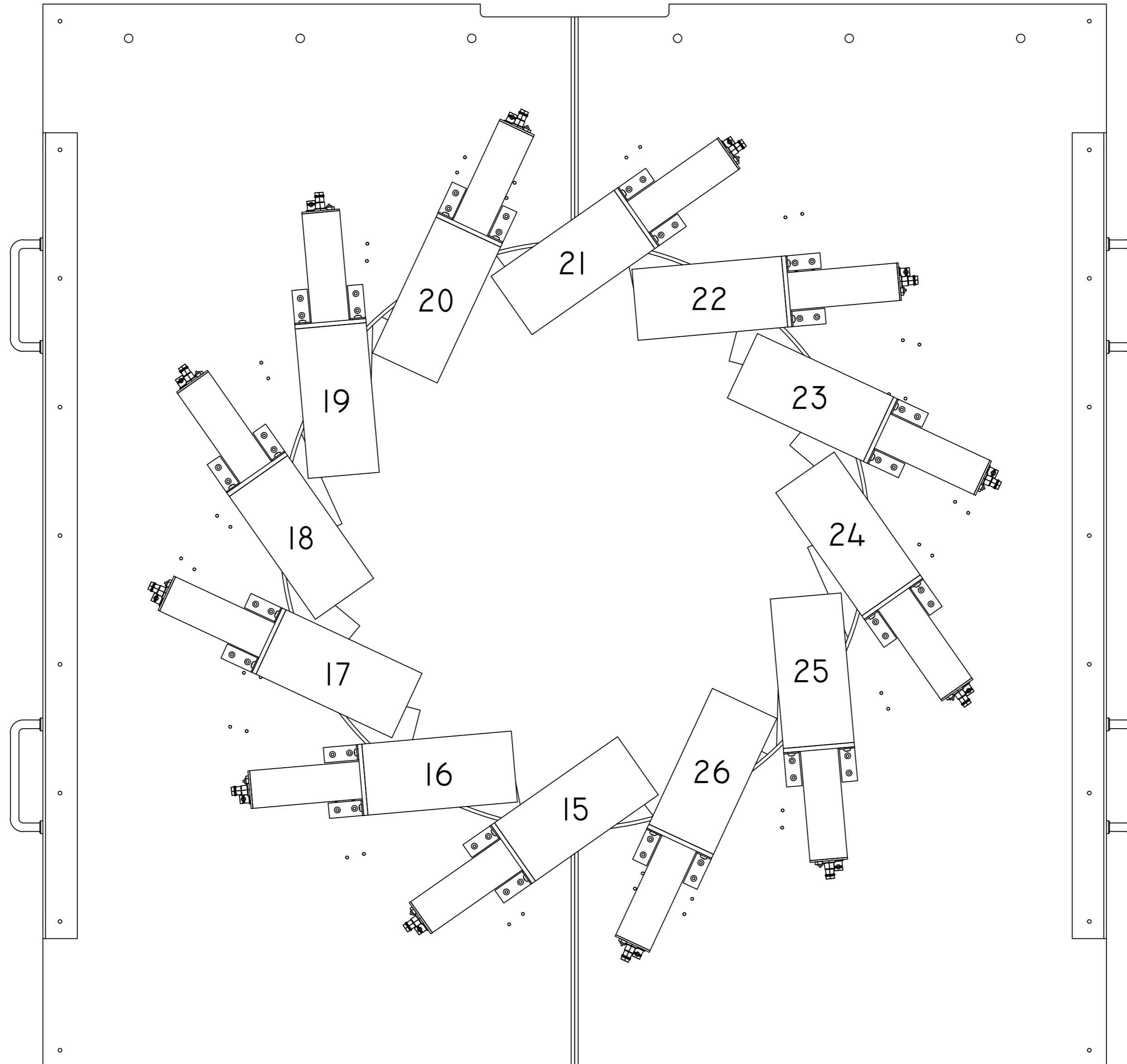

# LAYER 4

RESOLUTION ID

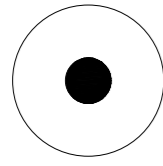

BEAM DIRECTION

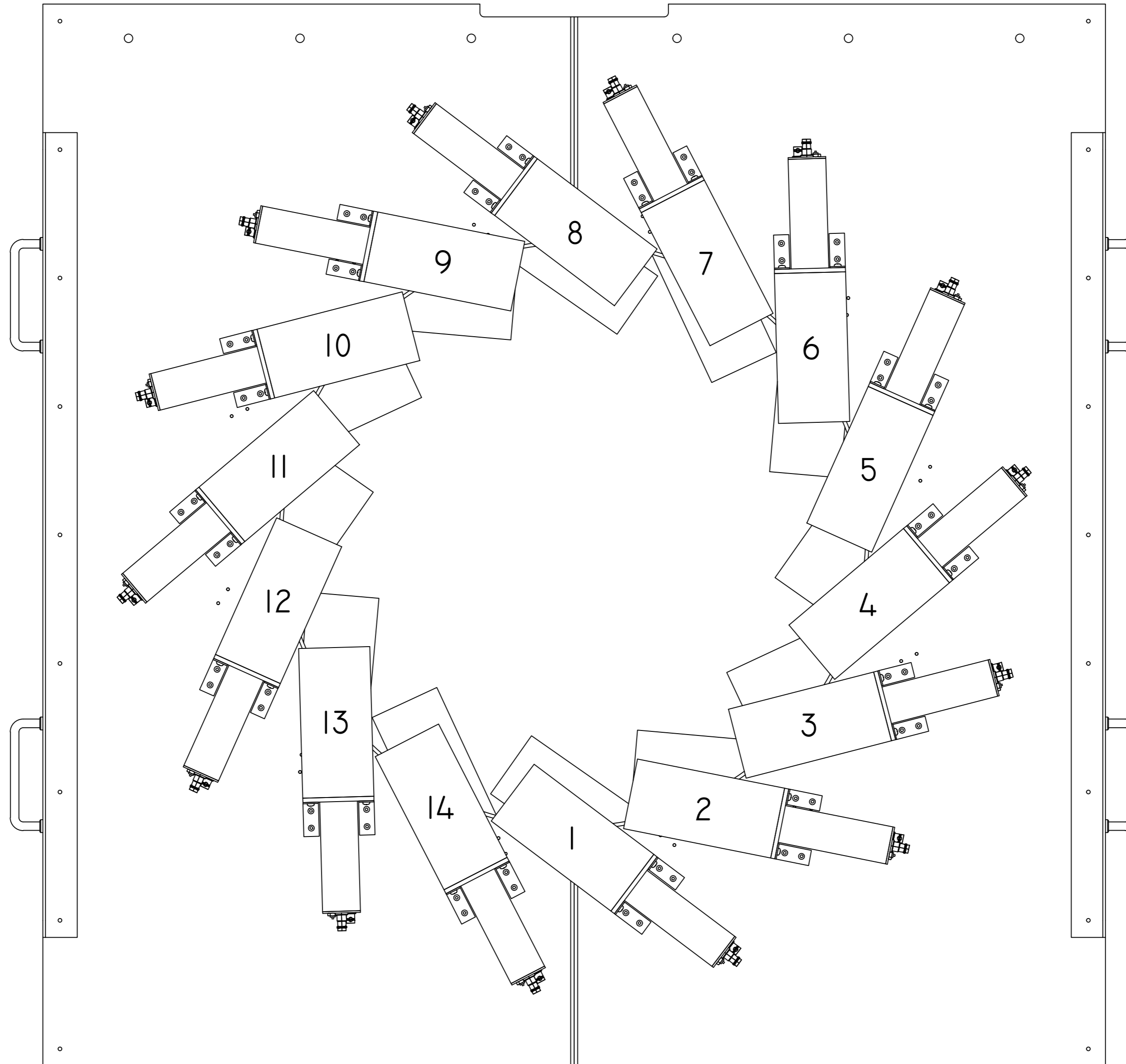

# LAYER 5

RESOLUTION ID

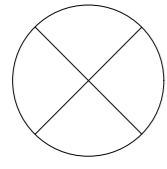

BEAM DIRECTION

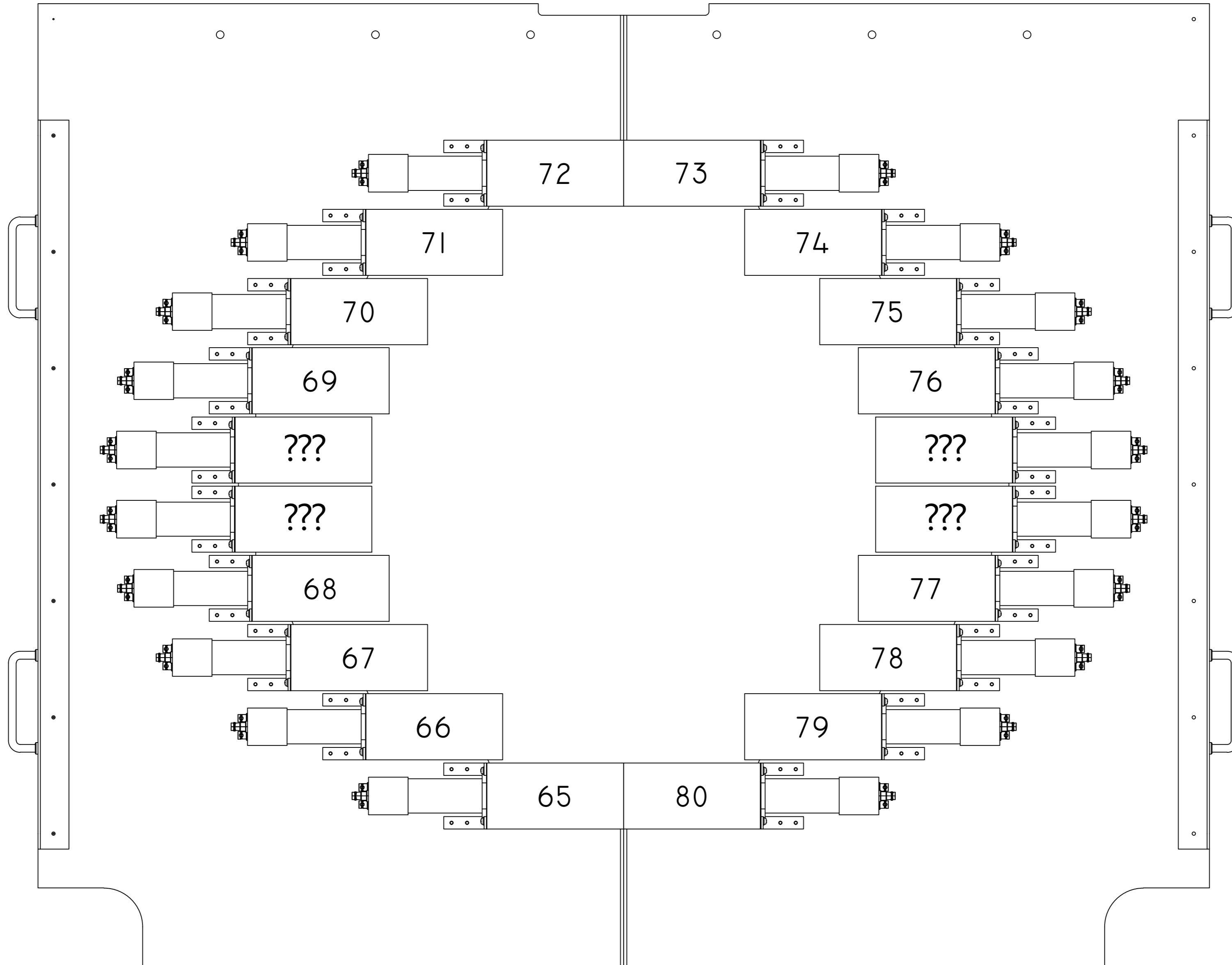

# LAYER 6

RESOLUTION ID

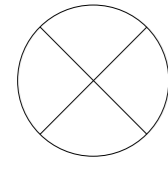

BEAM DIRECTION

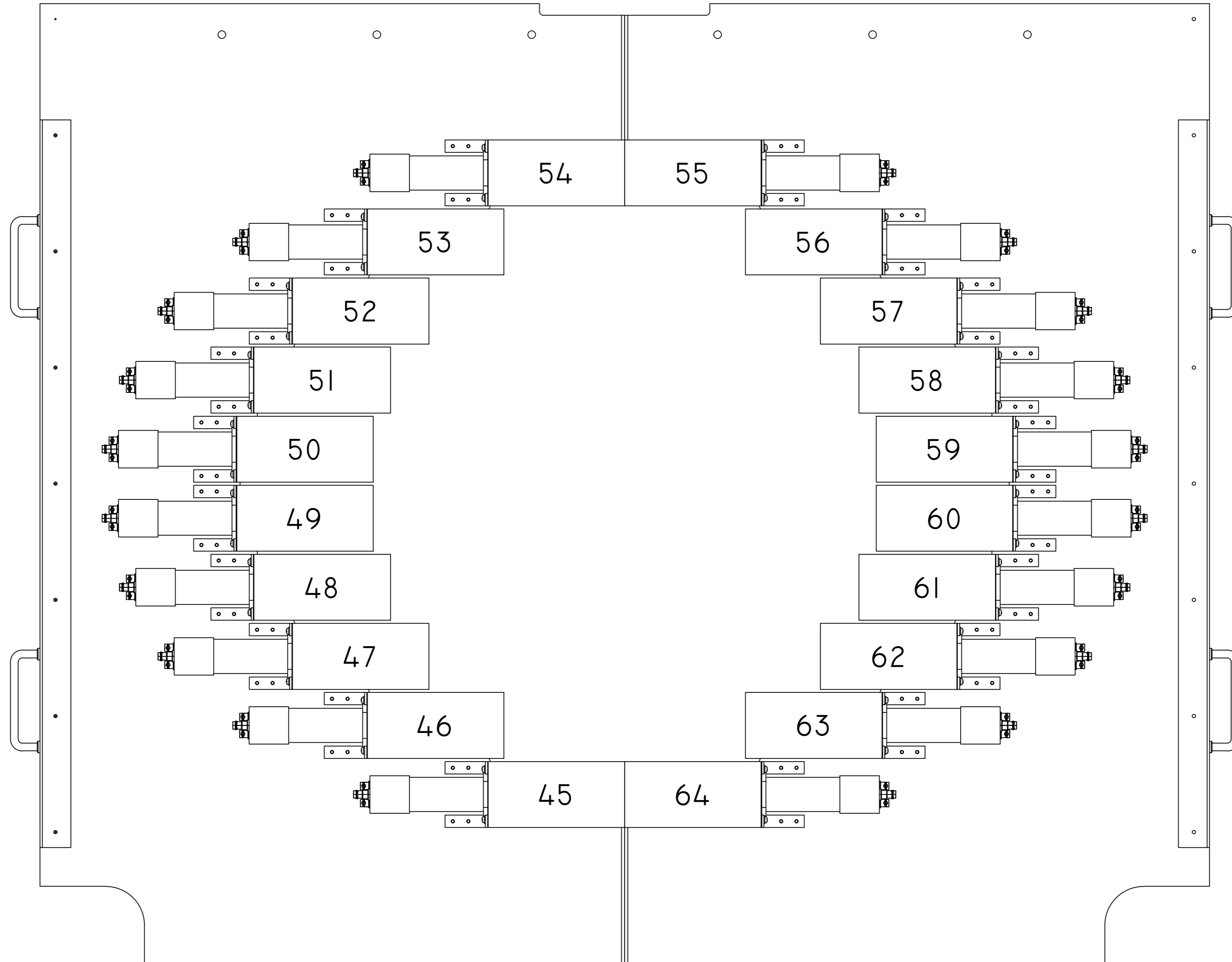

# LAYER 7

RESOLUTION ID

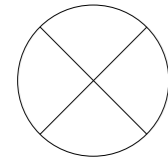

BEAM DIRECTION

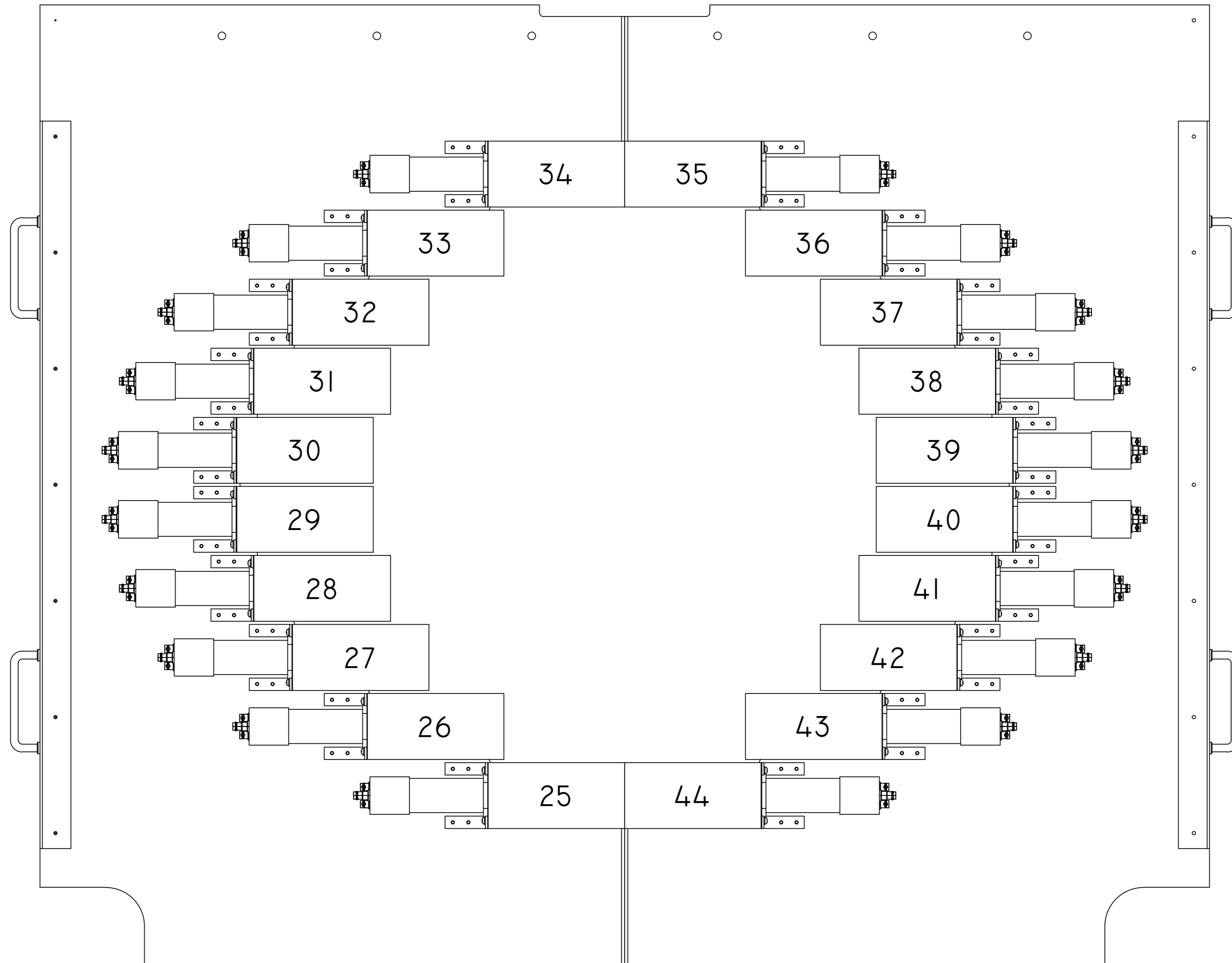

# LAYER 8

RESOLUTION ID

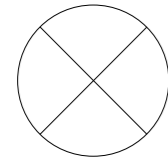

BEAM DIRECTION

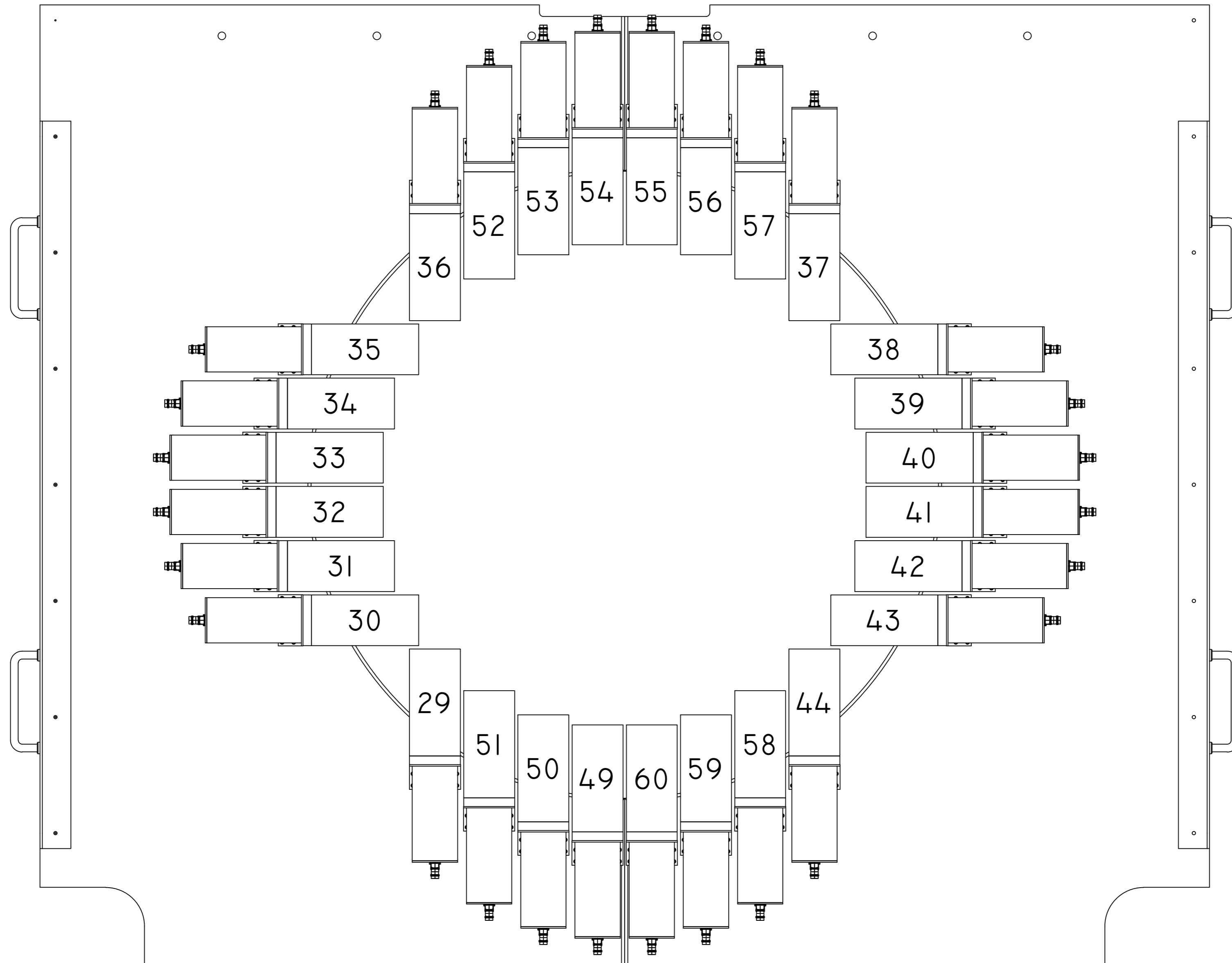



# LAYER 9

RESOLUTION ID

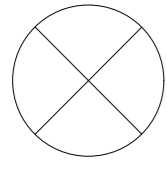

BEAM DIRECTION

